

AGENDA ITEM 6.1 (C) ATTACHMENT

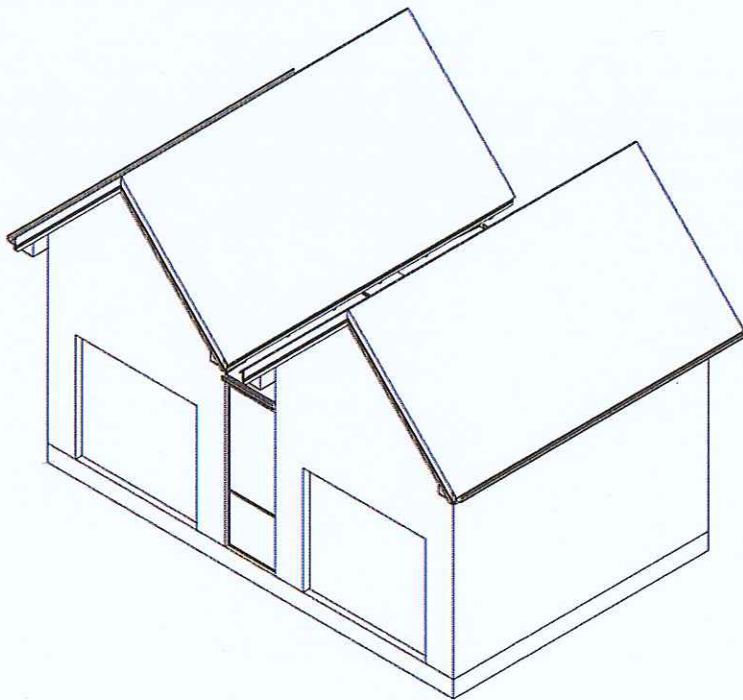

**LTD** LOUTON DESIGN PTY. LTD.  
ABN 62 051 259 591 ABA CC309W

95 MAIN ROAD, GEORGE TOWN, TAS, 7253  
PH 0419 00 1990  
PH/FAX 63 823 300

PROJID

**AR342**

TITLE

PROPOSED BOAT SHED DEVELOPMENT FOR  
MARY FLOOD, 371A LOW HEAD ROAD, LOW HEAD

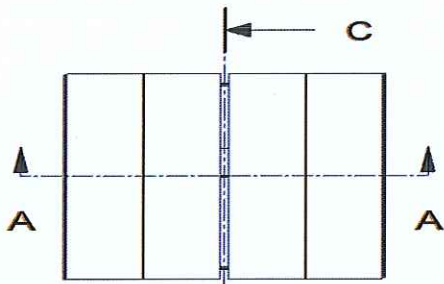

ROOF PLAN

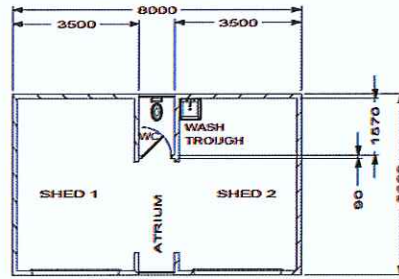

FLOOR PLAN

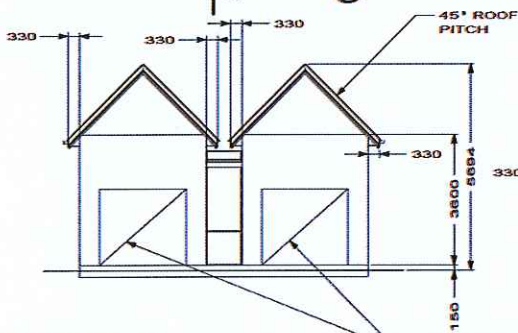

SOUTH ELEVATION

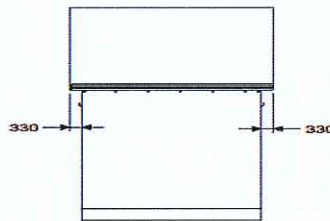

WEST ELEVATION

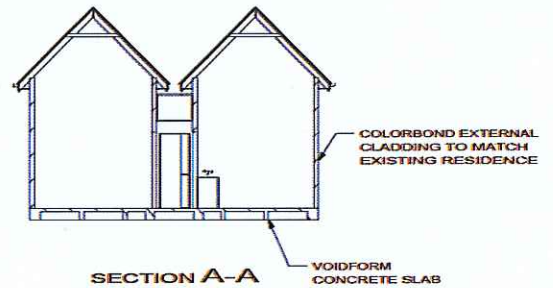

SECTION A-A

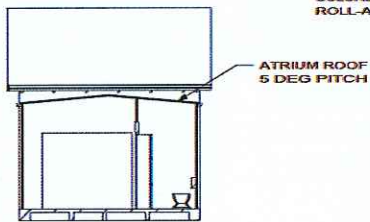

SECTION C-C

	<b>LOUTON DESIGN PTY. LTD.</b> ABN 152 091 299 991 82 MAIN ROAD, PO BOX 388, GARDISTON, TASMANIA, 7253 PH: 6332 1023 FAX: 6332 3300 EMAIL: info@louton.com.au WWW.LOUTONDESIGN.COM.AU	THIS DOCUMENT IS AND SHALL REMAIN THE PROPERTY OF LOUTON DESIGN PTY LTD IT IS TO BE USED WITHOUT FURTHER WRITTEN CONSENT.	DRAWN T HEWITT DATE 25/10/13 ARCH T HEWITT DATE 25/10/13 STATUS SCALE 1:100	PROJECT No <b>AR342</b>	DRAWING <b>201</b>	REV <b>4</b>	TITLE <b>PROPOSED BOAT SHED DEVELOPMENT FOR          MARY FLOOD, 371A LOW HEAD ROAD, LOW HEAD          BUILDING ELEVATIONS</b>

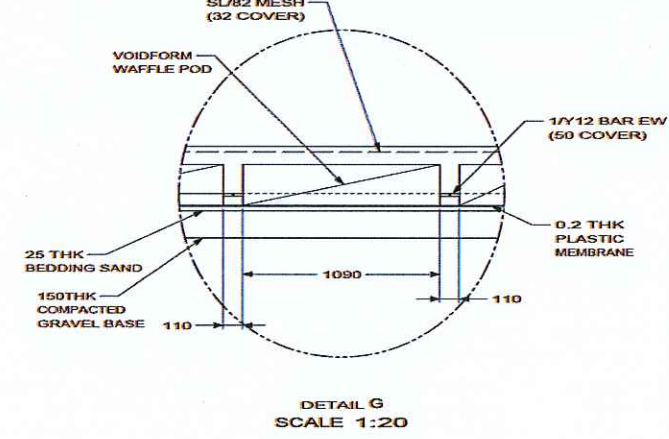
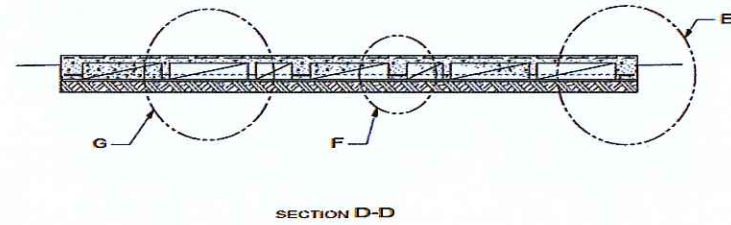
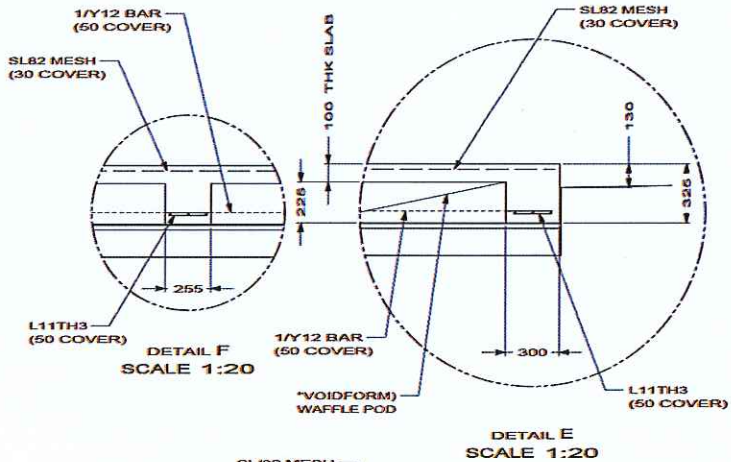
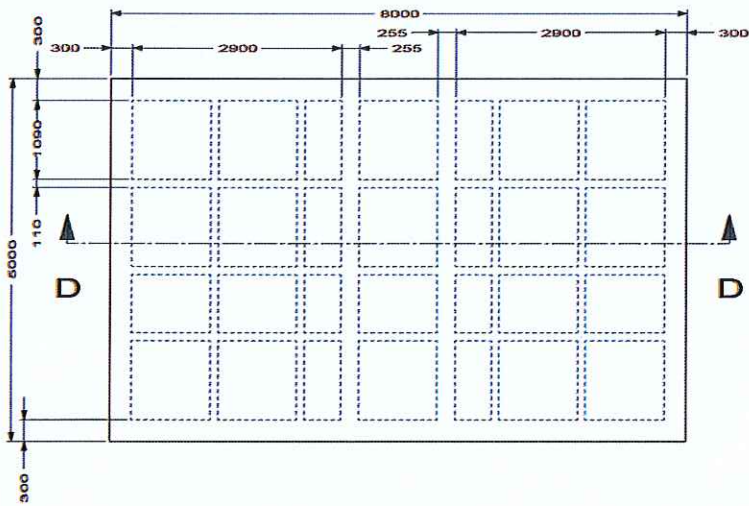

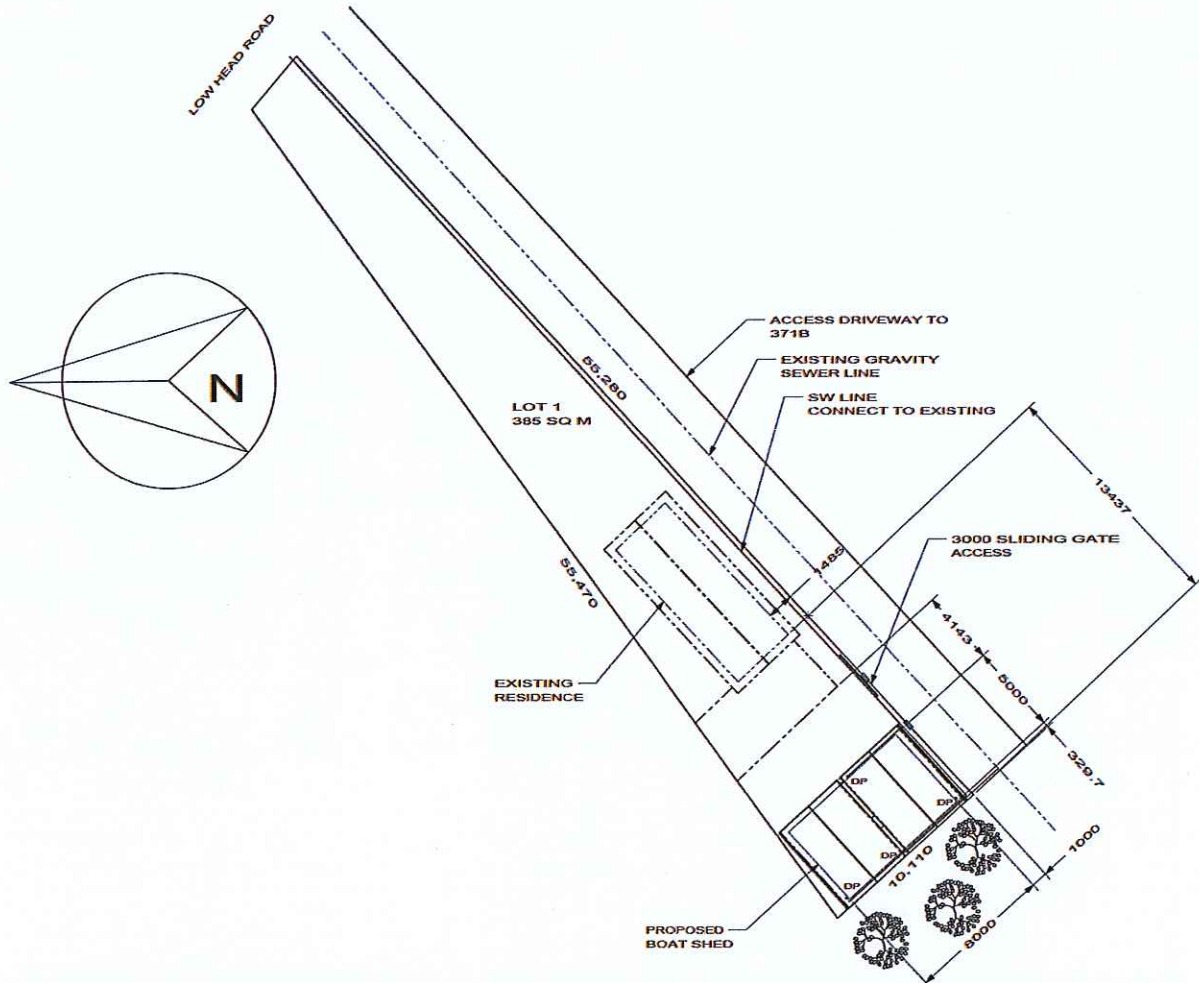

	<b>LOUTON DESIGN PTY. LTD.</b> ABN 922 094 258 591 82 MAIN ROAD, PO BOX 358, OROKAITEKI, TASMANIA, 7233	THIS DOCUMENT IS AND SHALL REMAIN THE PROPERTY OF LOUTON DESIGN PTY LTD IT SHOULD NOT BE USED WITHOUT WRITTEN CONSENT	DRAWN <b>T HEWITT</b> DATE <b>2/12/13</b> AUTH _____ DATE _____ STATUS _____ SCALE <b>1 : 100</b>	PROJECT No. <b>AR342</b>	Dwg No. <b>202</b>	REV. <b>4</b>	TITLE <b>PROPOSED BOAT SHED DEVELOPMENT FOR          MARY FLOOD, 371A LOW HEAD ROAD, LOW HEAD          SLAB DETAILS</b>
	82 MAIN ROAD, PO BOX 358, OROKAITEKI, TASMANIA, 7233	P.O. 6332 1024 FAX: 6342 3345 EMAIL: info@loutondesign.com.au WWW.LOUTONDISEIGN.COM.AU					



<b>LOUTON DESIGN PTY. LTD.</b> 95 MAIN ROAD, GEORGE TOWN PH/FAX: 63 823 300	DRAWN T HEWITT DATE 31/10/13 SCALE 1 : 200	ISSUE <b>4</b>	DRG NO <b>AR342-150</b>	TITLE PROPOSED BOAT SHED DEVELOPMENT FOR MARY FLOOD 371A LOW HEAD ROAD, LOW HEAD SITE PLAN
---	---	-------------------	----------------------------	---

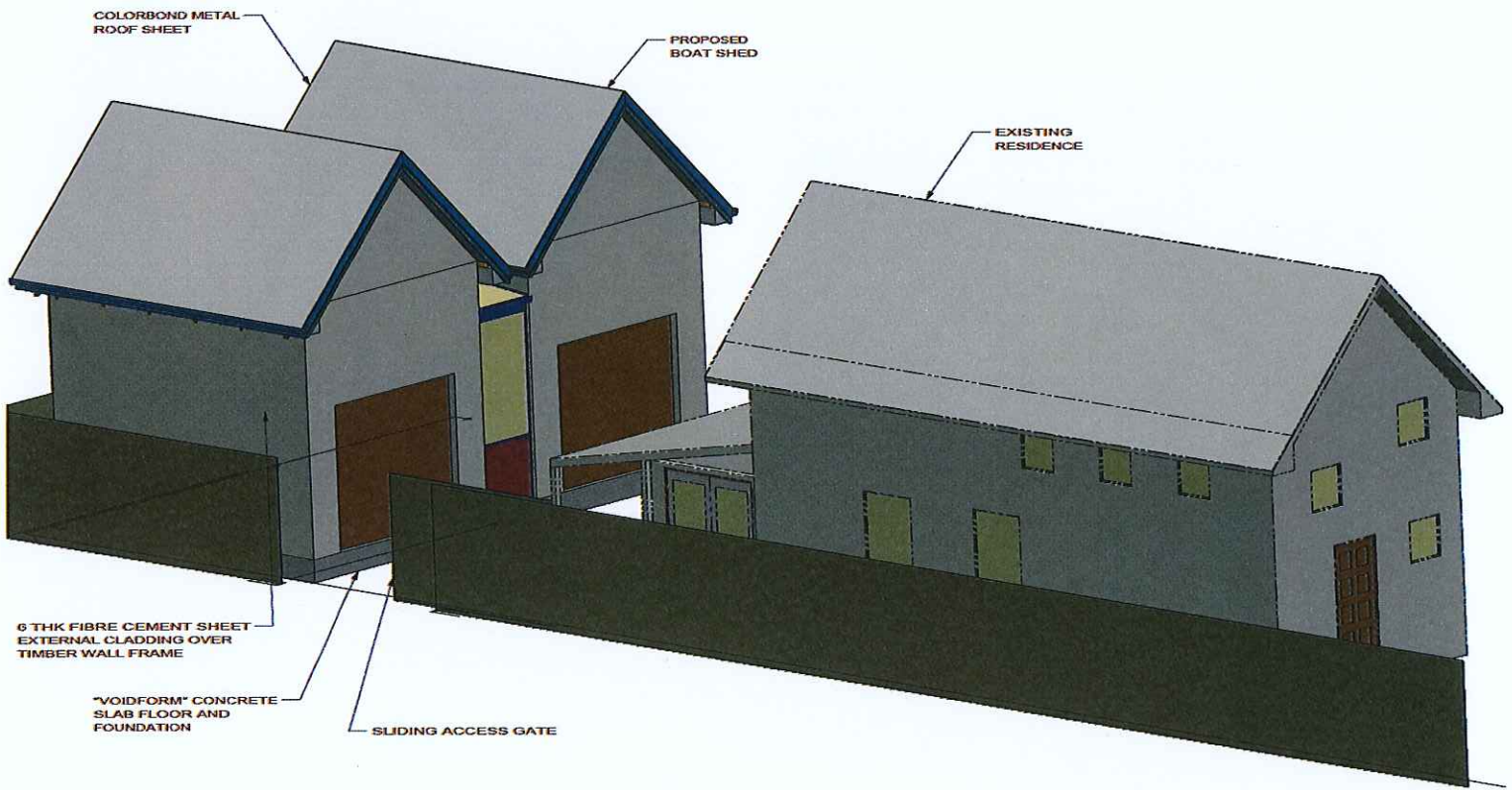



 <b>LOUTON DESIGN PTY. LTD.</b> ABN 62 091 208 591 ABA CC309W	95 MAIN ROAD, GEORGE TOWN, TAS, 7253 PH 0419 00 1990 PH/FAX 63 823 300	PROJID <b>AR342 000</b>	TITLE <b>PROPOSED BOAT SHED DEVELOPMENT FOR MARY FLOOD          371A LOW HEAD ROAD, LOW HEAD          COVER SHEET</b>
--	--	----------------------------	--